

Top 100
Global
Innovator
for 10 years

Susol RMU

Ring Main Unit

SF₆ Gas Insulated Ring Main Units



LS ELECTRIC

Contents

Features	04
Ordering information	06
Configurations (Extensible RMU)	07
Configuration (Non-Extensible RMU)	08
Main characteristics	10
Types and diagrams	11
Major components	12
Accessories	20
Dimensions	23



Susol Super Solution

RING MAIN UNIT

SF₆ Gas Insulated Ring Main Units

Based on maximizing efficiency and reliability of the power technology helps offering optimized solutions for your environment

Susol RMU is enable to install on medium voltage distribution network and mainly used for protection of transformers in compact substations. It is used for medium voltage distribution in compact substations, small buldings, residential housing complex, large shopping malls, airports, wind power, and solar power comprising medium voltage networks.

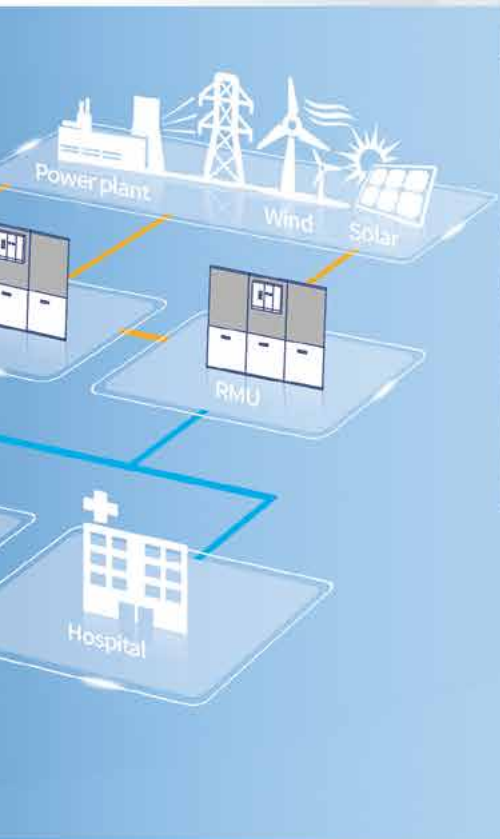

Certified Quality

STL (The Short-Circuit Testing Liaison, KERI), ISO 9001, ISO 14001 LS has integrated a functional organization into each of its units, the main purpose of which is to check quality and ensure the adherence to standards.

Features

Susol Super Solution

RING MAIN UNIT

SF₆ Gas Insulated Ring Main Units

Susol RMU is a compact ring main unit combining all MV functional units to enable to supply and protect transformers on the secondary distribution network.

Susol RMU can be supplied in various and different configurations suitable for most switching applications in 12 / 17.5 / 24kV / 36kV distribution networks



Technology

Technology

- Metal enclosed unit for indoor installation and type tested.
- Insulated by SF₆ Gas.
- Maintenance free and easy installation.
- Independent of climate.
- ON-OFF-Earth, 3-position load break switch



Safety

Safety

- Approachable and operable safety in the presence of power in the cables.
- Clear indication of operation status via mimic diagram on front panel.
- Fully automatic interlocking system.
 - Operation is only possible in case door is totally closed.
 - Fuse compartment is only accessible when Load break switch is earthed.
 - Voltage detector to check whether cables are lined or not
- Internal arc withstand is tested for the operator safety in case of accident current occur.



Durability

Durability and usefulness

- Metal enclosed tank is hermetically sealed, it means this is independent of environmental effects such as dirt, small insects, moisture and so on.
- Load break switch operating is possible in the front of Ring Main Unit.
- All switching operations can be made safely to personnel because of interlocking system that operates automatically according to the switch position by the operator.
- No requirement of recharging SF₆ gas until its service life.
- Remote operation available in case of using motor operating mechanism and RTU.
- HRC power fuse will trip the mechanism automatically by a fuse striker pin connected to mechanism in the event of fault happening.



Compact

Saving cost

- No maintenance is required other than replacement of HRC power fuse after installation.
- Compact design that requires minimum space to install and operate locally is main advantage especially where the space is limited.



Remote Control



Network remote control for DAS / SCADA

Equipped with RTU (Remote Terminal Unit), the Susol RMU switchgear can implement intelligent application.

Connecting all the IRMUs (Intelligent RMU) by a communication network, it enable to monitor and control the switchgear remotely, locate and isolate automatically as well as the system recovery.

This will dramatically reduce the affected area and duration of blackout, and realize the high reliability and excellent power quality.

RTU(Remote Terminal Unit)

- Equipped with RTU (Remote Terminal Unit), the susol RMU switchgear can implement intelligent application. connecting all Susol RMU with communication network, it enables to monitor and control the switchgear remotely.
- The remote terminal unit (RTU) collects data from field instruments & sensors and transmits the information to the Supervisory Control and data acquisition system (SCADA) installed in a central control room through communication systems and lines, and receives control commands from the telemeter telecontrol system to conduct online controls in real time.

System configuration

Susol RMU equipped with RTU provides all the functions needed to operate the MV network in real time

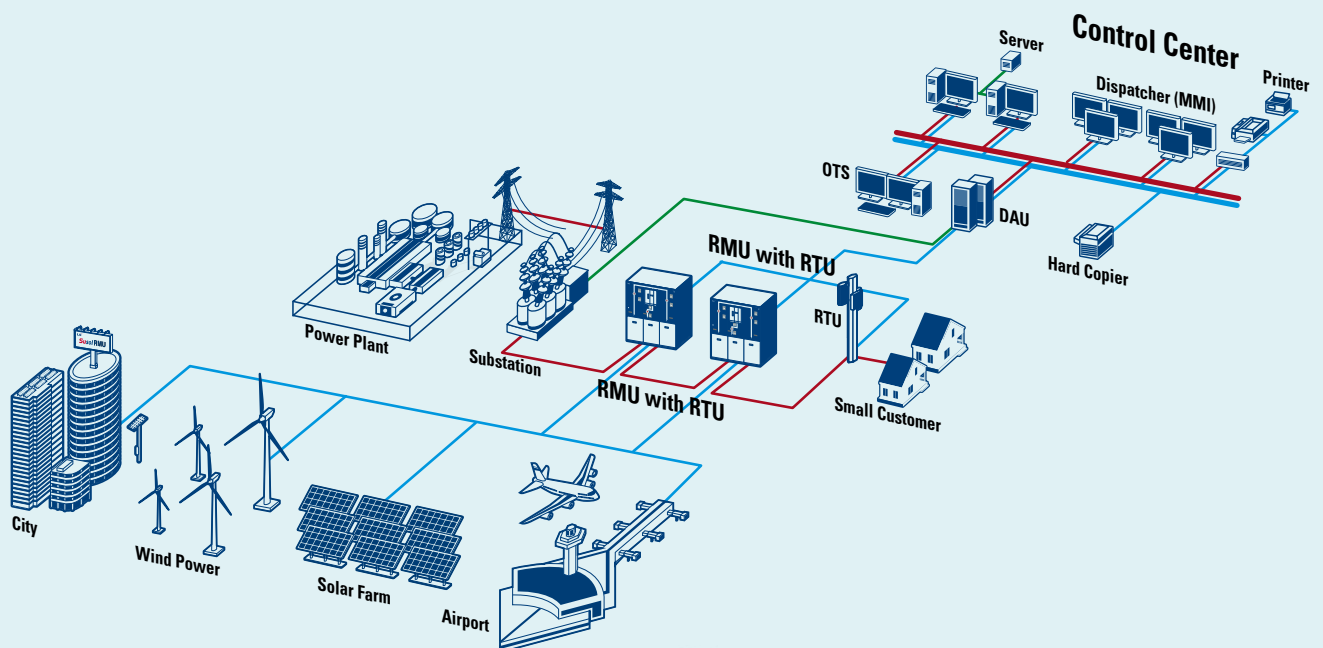

Ordering information

Extensible RMU

R			B		24		6		6		6		0	
Type	Code	Operation	Code	Rated voltage	Code	Rated current (Main)	Code	Rated current (T-OFF)	Code	Rated frequency	Code	Oder type		
R	B	Manual	24	24kV	6	630A	6	630A	6	60Hz	S	SKD		
L	A1	AC 110V	17	17.5kV			2	200A	5	50Hz	C	CKD		
C	A2	AC 220V	12	12kV					0	60/50Hz	0	Complete product		
F	D1	DC 110V												
LLCL	D2	DC 220V												

※ Note that LLCL Type is extensible to the right

Non-Extensible RMU

CB Feeder RMU

RC			B		36		6		6		6		0	
Type	Code	Operation	Code	Rated voltage	Code	Rated current (Main)	Code	Rated current (T-OFF)	Code	Rated frequency	Code	Oder type		
RC	B	Manual	36	36kV	6	630A	6	630A	6	60Hz	S	SKD		
LC	A1	AC 110V	24	24kV					5	50Hz	C	CKD		
LCL	A2	AC 220V	17	17.5kV					0	60/50Hz	0	Complete product		
LLCL	D1	DC 110V	12	12kV										
LCCL	D2	DC 220V												

Switch-fuse Feeder RMU

RF			B		24		6		2		0		0	
Type	Code	Operation	Code	Rated voltage	Code	Rated current (Main)	Code	Rated current (T-OFF)	Code	Rated frequency	Code	Oder type		
RF	B	Manual	24	24kV	6	630A	2	200A	0	60/50Hz	S	SKD		
LF	A1	AC 110V	17	17.5kV							C	CKD		
LFL	A2	AC 220V	12	12kV							0	Complete product		
LLFL	D1	DC 110V												
LFFL	D2	DC 220V												

LBS Feeder RMU

LR			B		24		6		0		0		0	
Type	Code	Operation	Code	Rated voltage	Code	Rated current (Main)	Code	Rated current (T-OFF)	Code	Rated frequency	Code	Oder type		
LR	B	Manual	24	24kV	6	630A	0	N / A	0	60/50Hz	S	SKD		
LLL	A1	AC 110V	17	17.5kV							C	CKD		
LLLL	A2	AC 220V	12	12kV							0	Complete product		
	D1	DC 110V												
	D2	DC 220V												

Product Types

R: Riser

L: LBS (Load Break Switch)

C: CB (Vacuum Circuit Breaker With Disconnecting Switch)

F: Fuse (Load Break Switch-Fuse Combination)

Ratings

Type : Susol RMU LLCLPx(Extensible type)
 Rated voltage : 12/17.5/24kV
 Rated frequency : 50Hz
 Rated current : 630A
 Rated short time current : 21kA/3s
 Power frequency withstand voltage : 42kV
 Lightning impulse withstand voltage : 75kV
 Internal arc withstand class : AFLR or AFL 21kA/1s
 Applicable standards : IEC 62271-1, 102, 103, 200
 Operating method : Trip coil

Diagram Example

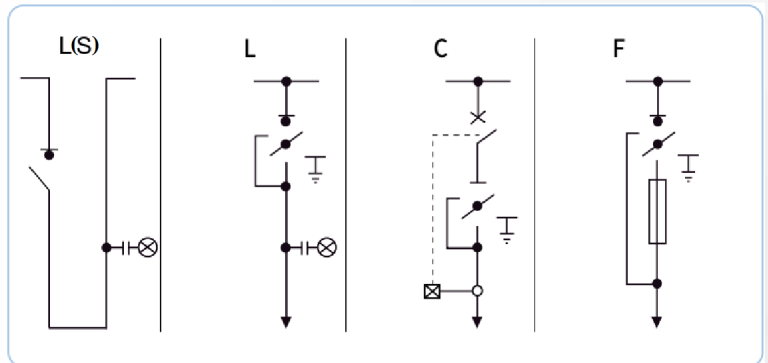

LBS Feeder (L)

L: LBS(Load Break Switch)
 3-position Load break switch rated 630A and less for load breaking and earthing

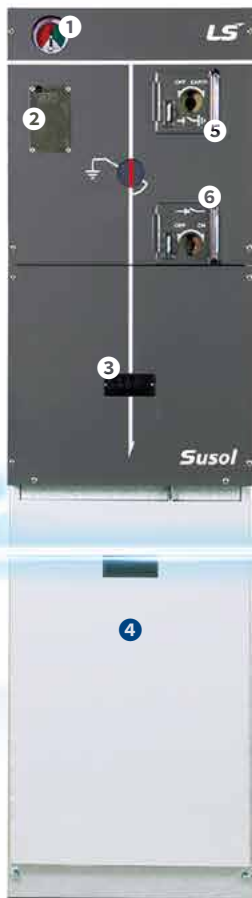

CB Feeder (C)

C: VCB (Vacuum Circuit Breaker)
 Circuit breaker with 21kA interrupting capacity for the transformer and line protection



Switch-Fuse Feeder (F)

F: Switch Fuse
 (Load Break Switch-Fuse Combination)
 200A switch-fuse combination for transformer protection

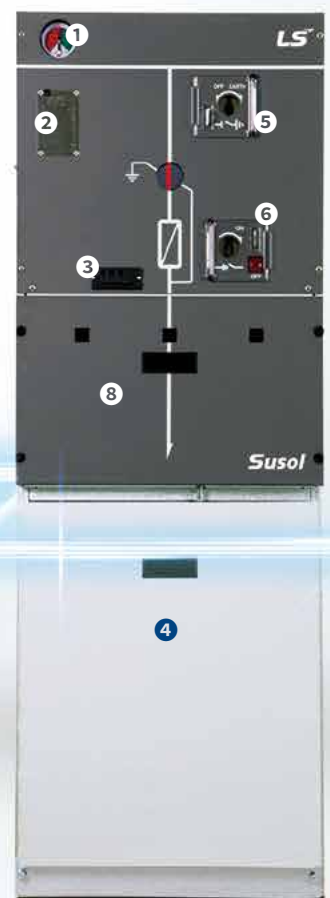

- 1 Pressure gauge
- 2 Name plate
- 3 Voltage detector
- 4 Cable compartment
- 5 Ring S/W Earth operation
- 6 Ring S/W operation
- 7 Circuit breaker operation
- 8 Fuse compartment

Configurations Non-extensible RMU

Diagram Example

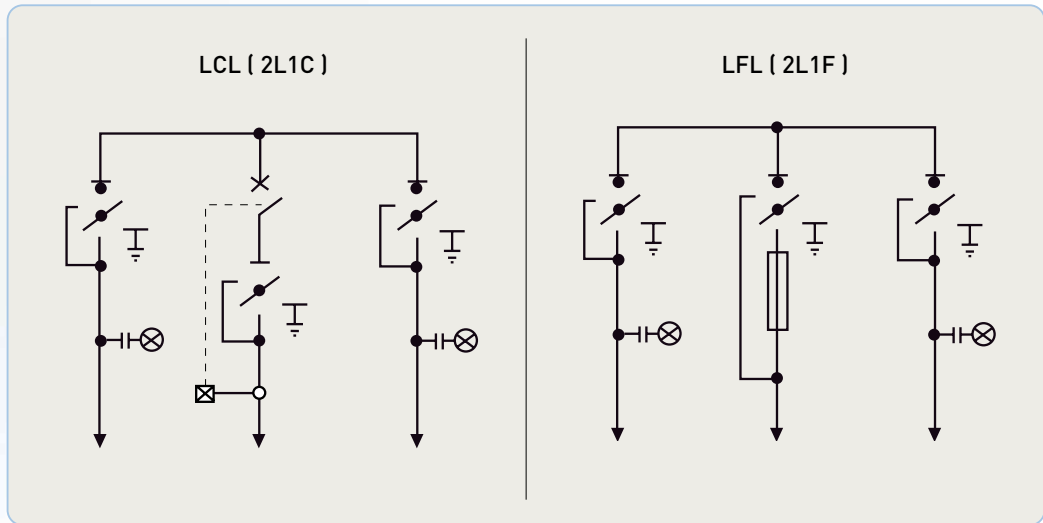

12/17.5/24kV Non-extensible CB feeder RMU

2 LBS & 1 CB-DS in single chamber.

L: LBS (Load Break Switch)

3-position Load Break Switch rated 630A and less for load breaking and earthing

C: VCB (Vacuum Circuit Breaker)

Circuit Breaker with 21kA interrupting capacity for the transformer and line protection

Horizontal Cable Bushing in Front

- ① Name plate
- ② Ring S/W earth operation
- ③ Circuit breaker operation
- ④ Ring S/W operation
- ⑤ Pressure gauge
- ⑥ Voltage indicator
- ⑦ Cable compartment
- ⑧ Fuse compartment



36kV Non-extensible CB feeder RMU

2 LBS & 1 Switch-Fuse in single chamber.

L: LBS (Load Break Switch)

3-position load break switch with a rating of 630A or less for load break and earthing

C: VCB (Vacuum Circuit Breaker)

20kA circuit breaker with interrupting capacity for the transformer and line protection

Horizontal Cable Bushing in Front



12/17.5/24kV Non-extensible switch-fuse feeder RMU

2 LBS & 1 Switch-fuse in single chamber.

L: LBS (Load Break Switch)

3-position Load break switch rated 630A and less for load breaking and earthing

F: Switch Fuse (Load Break Switch-Fuse Combination)

200A switch-fuse combination for transformer protection

Horizontal Cable Bushing in Front



Main characteristics

Rating

Conditions		Description			
Rated voltage	kV	12	17.5	24	36
Rated frequency	Hz	50/60	50/60	50/60	50/60
Rated power frequency withstand voltage	kV	28	38	50	70
Rated lightning impulse withstand voltage	kV	75	95	125	170
Rated current main busbars	A	630	630	630	630
Rated short-time withstand current (3s)	kA	21	21	21	20
Rated short-circuit making current	kA	52(50Hz) / 54.6(60Hz)			52(50, 60Hz)
Rated withstand arc current (1s, AFLR)	kA	21	21	21	20
Rated SF ₆ gas pressure	psi.G	5	5	5	5

Standards

Standard	Description
IEC 62271-1	High-Voltage Switchgear and Controlgear Part 1: Common Specifications
IEC 62271-100	High-Voltage Switchgear and Controlgear Part 100: Alternating-Current Circuit-Breakers
IEC 62271-102	High-Voltage Switchgear and Controlgear Part 102: Alternating Current Disconnectors and Earthing Switches
IEC 62271-103	High-Voltage Switchgear and Controlgear Part 103: Switches for Rated Voltages Above 1 kV up to and Including 52 kV
IEC 62271-105	High-Voltage Switchgear and Controlgear Part 105: Alternating Current Switch-fuse Combinations High-Voltage Switchgear and Controlgear
IEC 62271-200	Part 200: AC Metal-Enclosed Switchgear and Controlgear for Rated Voltages Above 1 kV and up to and Including 52 kV

Environment conditions

Conditions	Description
Temperatures	<ul style="list-style-type: none"> • Products should be stored and installed under the following conditions. • For stocking : from -40 °C to +60 °C • For working : from -25 °C to +45 °C • Other temperature, consult us.
Altitude	<ul style="list-style-type: none"> • Altitude for installation above sea level : under 1, 000 m
Humidity	<ul style="list-style-type: none"> • Relative humidity : max. 100 %

Additional information

Conditions	Description
Options	<ul style="list-style-type: none"> • Manometer • VIS (Voltage Indication Systems) • All cable covers with interlock system • Fuse cover with interlock system
User options	<ul style="list-style-type: none"> • Internal arc exhausting box for 21kA / 1s • Remote operating system for load break switch • Remote operating system for fuse combination switch • Remote operating system for circuit breaker • OCR (Over Current Relay) operating circuit breaker • Padlock system (key locking devices) • Remote operating system for load break switch • Remote operating system for fuse combination switch • Remote operating system for circuit breaker • OCR(Over Current Relay) for circuit breaker • Padlock system (key locking devices)
Protection index	<ul style="list-style-type: none"> • IP 3X: on front face, IP67 for SF₆ tank

Non-extensible RMU

12/17.5/24kV CB Feeder RMU

Dimension (W×H×D), mm

RC (1R1C)	LC (1L1C)	LCL (2L1C)	LLCL (3L1C)	LCCL (2L2C)
718×1,437×779	718×1,437×779	1,030×1,437×779	1,362×1,437×779	1,362×1,437×779

36kV CB Feeder RMU

RC (1R1C)	LC (1L1C)	LCL (2L1C)	LLCL (3L1C)	LCCL (2L2C)
1,015×1,607×1,108	1,015×1,607×1,108	1,375×1,607×1,108	1,950×1,607×1,108	2,020×1,607×1,108

12/17.5/24kV Switch-Fuse Feeder RMU

RF (1R1F)	LF (1L1F)	LFL (2L1F)	LLFL (3L1F)	LFFL (2L2F)
718×1,437×779	718×1,437×779	1,030×1,437×779	1,362×1,437×779	1,362×1,437×779

12/17.5/24kV LBS Feeder RMU

LR (1L1R)	LLL (3L)	LLLL (4L)
718×1,222×779	1,030×1,222×779	1,362×1,222×779

12/17.5/24kV Extensible RMU

L(S)	L	C	F	LLCL+
430×1,600×779	380×1,600×779	500×1,600×779	430×1,600×779	1,395×1,600×779

Major components

Circuit Breaker

Rating

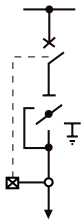

Conditions	Description				
Rated voltage	kV	12	17.5	24	36
Rated frequency	Hz	50/60	50/60	50/60	50/60
Rated power frequency withstand voltage	kV	28	38	50	70
Rated lightning impulse withstand voltage	kV	75	95	125	170
Rated current	A	630	630	630	630
Rated short-time withstand current (3s)	kA	21	21	21	20
Rated short-circuit making current	kA	52(50Hz) / 54.6(60Hz)			52(50,60Hz)
Electrical endurance class		E2/C2	E2/C2	E2/C2	E2/C2
Mechanical endurance class		M1	M1	M1	M1
Disconnecter and Earthing switch					
Rated current	A	630	630	630	630
Rated short-time withstand current (3s)	kA	21	21	21	20
Rated short-circuit making current	kA	52(50Hz) / 54.6(60Hz)			52(50,60Hz)
Electrical endurance class (Earthing switch)		E1	E1	E1	E1
Mechanical endurance class (Disconnecter)		M1	M1	M1	M1
Mechanical endurance class (Earthing switch)		M0	M0	M0	M0



12/17.5/24kV CB module



36kV CB module

Standard / Optional features

• Standard features

- Circuit Breaker with 21kA interrupting capacity for the transformer and line protection
- 3-position DS disconnecting and earthing switch
- Switch position indication for CB and DS / ES
- Cable bushing horizontal in front
- Interlocking between CB and DS / ES

• Optional features

- Motor operation for Circuit Breaker
- Auxiliary switches
 - CB position
 - Disconnector position
 - Earthing switch position
- Voltage indicating system
- Trip coil and close coil

Vacuum interrupter

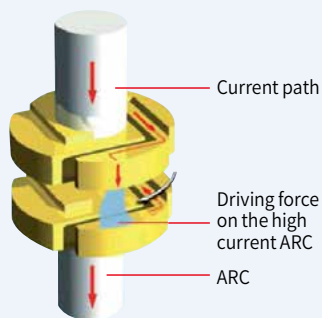

In the closed position, normal current flows through the interrupter. When a fault occurs and interruption is required, the contacts are quickly separated. The arc drawn between the surfaces of contact is rapidly moved around the slotted contact surface by self induced magnetic effects, preventing gross contact erosion and the formation of hot spot on the surface. The arc burns in an ionized metal vapor, which condenses on the surrounding metal shield. At current zero the extinguishes and vapor production ceases. The metal vapor plasma is very rapidly dispersed, cooled, recombined, and deionized, and the metal vapor products are quickly condensed so that the contacts withstand the transient recovery voltage.

Switch Fuse Combination

Rating

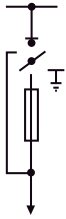

Conditions		Description		
Rated voltage	kV	12	17.5	24
Rated frequency	Hz	50/60	50/60	50/60
Rated power frequency withstand voltage	kV	28	38	50
Rated lightning impulse withstand voltage	kV	75	95	125
Rated current	A	200	200	200
Electrical endurance class		E3	E3	E3
Mechanical endurance class		M1	M1	M1
Earthing switch				
Rated short-time withstand current (3s)	kA	5	5	5
Rated short-circuit making current	kA	13	13	13
Electrical endurance class		E1	E1	E1
Mechanical endurance class		M0	M0	M0



Standard / Optional features

• Standard features

- 3-position switch-fuse combination with earthing switch
- Switch position indication for switchfuse combination and earth switch
- Cable bushing horizontal in front
- Fuse holder for DIN type fuse-links
- Fuse-link rating
 - 12 / 17.5kV : max. 100 A, LS DIN type fuse-link
 - 24kV : max. 75 A, LS DIN type fuse-link

• Optional features

- Motor operation for switch-fuse combination
- Auxiliary switches
 - LBS position
 - Earthing switch position
 - Fuse blown status
- Voltage indicating system
- Trip coil

Major components

Load Break Switch

Rating

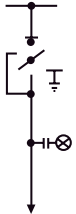

Conditions		Description			
Rated voltage	kV	12	17.5	24	36
Rated frequency	Hz	50/60	50/60	50/60	50/60
Rated power frequency withstand voltage	kV	28	38	50	70
Rated lightning impulse withstand voltage	kV	75	95	125	170
Rated current	A	630	630	630	630
Rated short-time withstand current (3s)	kA	21	21	21	20
Rated short-circuit making current	kA	52(50Hz) / 54.6(60Hz)			52(50,60Hz)
Electrical endurance class		E3/C2	E3/C2	E3/C2	E3/C2
Mechanical endurance class		M1	M1	M1	M1
Earthing switch					
Rated short-time withstand current (3s)	kA	21	21	21	20
Rated short-circuit making current	kA	52(50Hz) / 54.6(60Hz)			52(50,60Hz)
Electrical endurance class		E1	E1	E1	E1
Mechanical endurance class		M0	M0	M0	M0

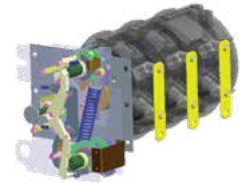

12 / 17.5 / 24kV LBS module



36kV LBS module

Standard / Optional features

• Standard features

- 3-position Load Break Switch rated 630A and less for load breaking and earthing
- Operating mechanism with two separate shaft for load and earthing function
- Switch position indication for LBS and ES
- Cable bushing horizontal in front with integrated capacitor for voltage indication

• Optional features

- Motor operation for load break switch
- Auxiliary switches
 - Load break switch position
 - Earthing switch position
- Voltage indicating system
- Short circuit and earth fault indicator

Operation of 3-position Load Break Switch

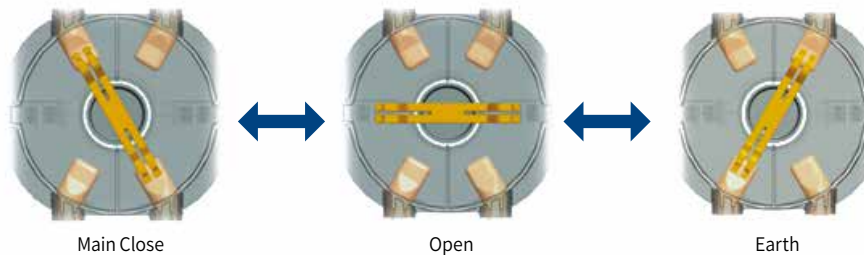

Cable Compartment

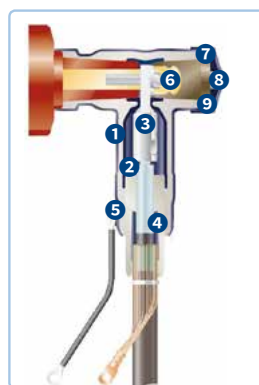
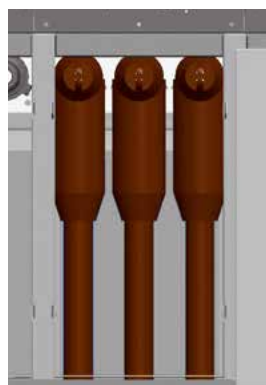

- 1 Screened Body
- 2 Inner Screen
- 3 Compressing lug
- 4 Stress Cone Adapter
- 5 Earthing Eye And lead
- 6 Threaded Pin
- 7 Rear Plug With Test Point
- 8 Test Point
- 9 Conductive End Cap

Trip Relay

Standard OCR

- Performing optimum relay operation
- Overload protection
 - 51T Protection characteristic (Curve selection)
 - 51D Protection characteristic (Definite time characteristic)
- Ground fault protection
 - 51ND protection characteristic (Definite time characteristic)
- Remote trip function
- Self power
- Viewing fault records via PC manager



- 1 LED : Indication of trip information and power status

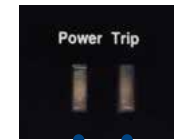

Trip : Indication of trip
Power : Indication of power status

- 2 Reset key : Trip initialization
3 I> : 51T current setting
tI> : 51T time delay and lever setting
4 Cv : 51T operation curve setting
5 I>> : 51D current setting
tI>> : 51D time delay setting
6 In : rated current setting
7 IE> : ground fault current setting
tIE> : ground fault time delay setting
8 Automatically tripped : to protect from fault current when a fuse is blown

Premium OCR

- Dual-powered protective relay
 - Self-Power (CT)
 - Auxiliary power: AC/DC 100~220V 50/60Hz
- Overload protection (49/50/51)
 - Low current region (definite/inverse time, thermal characteristics)
 - High current region (instantaneous time characteristic)
- Ground fault protection (50N/51N)
 - Low current region (definite/inverse time characteristics)
 - High current region (instantaneous time characteristic)
- LCD user interface
- Event/Fault history search function
 - 128 system events can be saved
 - 10 fault events can be saved
 - 1 fault waveform can be saved
- Remote monitoring function (RS-485 network)



- 1 LED : Indication of trip information and power status

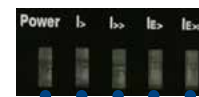

Overcurrent Ground Trip Status Display
Overcurrent Trip Status Display
Power Status Display

- 2 User interface button



Button	Basic function
M	Changes the screen mode.
⚓	Fixed to current screen. (Screen on measurement gauge)
△	Moves to previous item.
▽	Moves to next item.
↩	Saves the current value.
Reset Esc	1. (3 seconds) clears the trip alarm. 2. (Short) cancels the current insertion (Setup screen) or returns to the screen on measurement.

Major components

Trip Relay

Protection

50/51(Low Current), 49																	
Current Setting Range(A)	I>=In*...	0.9	0.95	1	1.05	1.1	1.15	1.2	1.3	1.4	1.5	1.6	1.8	2	2.25	2.5	NA
Time Delay(s)	tl>	a	b	c	d	e	f	g	h	i	j	k	l	m	n	o	p
	tl>@(DT Curve)	0.04	0.3	0.6	1	2	3	4	6	8	10	15	30	60	120	210	300
	tl>@(Thermal Curve)	0.5 ~ 300															
Lever	tl>@(INV Curve)	0.05	0.1	0.2	0.3	0.4	0.5	0.6	0.8	1	2	3	4	5	6	8	10
51D																	
Current Setting Range(A)	I>>=In*...	1	2	3	4	5	6	7	8	9	10	12	14	16	18	20	NA
Time Delay(s)	tl>>@1*In	0.04	0.07	0.1	0.15	0.2	0.25	0.3	0.4	0.6	0.8	1	1.4	1.8	2.2	2.6	3
Accuracy ±15% or ±40ms	Min.Trip Time(s)	0	0.03	0.06	0.11	0.16	0.21	0.26	0.34	0.51	0.68	0.85	1.19	1.53	1.87	2.21	2.55
	Max.Trip Time(s)	0.08	0.11	0.14	0.19	0.24	0.29	0.35	0.46	0.69	0.92	1.15	1.61	2.07	2.53	2.99	3.45
51ND																	
Current Setting Range(A)	IE>=In*...	0.2	0.3	0.4	0.5	0.6	0.7	0.8	0.9	1	1.2	1.4	1.6	1.8	2	2.5	NA
Time Delay(s)	tl>>@1*In	0.1	0.2	0.4	0.6	0.8	1	1.5	2	2.5	3	3.5	4	6	8	10	20
Accuracy ±15% or ±40ms	Min.Trip Time(s)	0.06	0.16	0.34	0.51	0.68	0.85	1.28	1.7	2.13	2.55	2.98	3.4	5.1	6.8	8.5	17
	Max.Trip Time(s)	0.14	0.24	0.46	0.69	0.92	1.15	1.73	2.3	2.88	3.45	4.03	4.6	6.9	9.2	11.5	23

※ Note

-51ND(Ground fault protection) normally operates when the sum of the RMS current of each phase measured by OCR is more than 90% of the minimum set value to the direction of P1 → P2 of the connected CT.

-If the sum of the RMS current of each phase at cold state is less than 2 times of the minimum set value, the absolute error of ±200ms should be added to the basic error

Operating characteristic

51T characteristic

The function for overload protection which has definite time characteristic and time delayed in inverse ratio to fault current.

- Pickup current setting Knob: I>
 - Setting range
(0.9-0.95-1.0-1.05-1.1-1.15-1.2-1.3-1.4-1.5-1.6-1.8-2.0-2.25-2.5-NA)*In
- Time delay setting Knob: tl>
 - Operation time based on 1 * I>
 - DT Setting range: 0.04-0.3-0.6-1-2-3-4-6-8-10-15-30-60-120-210-300 sec
 - INV Setting range (Lever value): 0.05-0.1-0.2-0.3-0.4-0.5-0.6-0.8-1-2-3-4-5-6-8-10
- Operation current based on the largest one of the three phases

*Trip time for INV curve setting

$$\text{trip time} = \left[\frac{A}{\left(\frac{I_f}{I_s} \right)^B - 1} + C \right] \times T/L + DT$$

*If : fault current, Is: set current, DT=0 for INV, T/L=0 for for DT

*Constants by curve

	A	B	C
IEC SI	0.14	0.02	0
IEC VI	13.5	1	0
IEC EI	80	2	0
IEC LI	120	1	0
ANSI SI	0.0515	0.02	0.114
ANSI VI	19.61	2	0.491
ANSI EI	28.2	2	0.1217
KEPCO SI	0.11	0.02	0.42
KEPCO VI	39.85	1.95	1.084

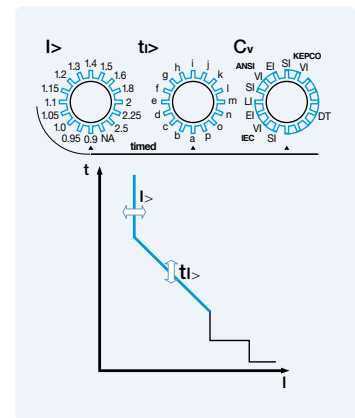

Operating characteristic

51D characteristic

The function for over current protection which has a definite time characteristic.

1. Standard current setting Knob: I>>
 - Setting range: (1-2-3-4-5-6-7-8-9-10-12-14-16-18-20-NA)*I_n
2. Time delay setting Knob: tI>>
 - Setting range: 0.04-0.07-0.1-0.15-0.2-0.25-0.3-0.4-0.6-0.8-1-1.4-1.8-2.2-2.6-3.0 sec
3. Operation current based on the largest one of the three phases

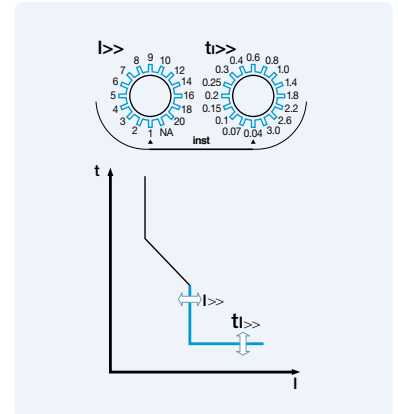

51ND characteristic

Ground fault protection function provides trip signal at the set values for pickup current and time delay.

1. Standard current setting Knob: IE>
 - Setting range: (0.2-0.3-0.4-0.5-0.6-0.7-0.8-0.9-1-1.2-1.4-1.6-1.8-2-2.5-NA)*I_n
2. Time delay setting Knob: tIE>
 - Setting range: 0.1-0.2-0.4-0.6-0.8-1-1.5-2-2.5-3-3.5-4-6-8-10-20 sec
3. Ground fault current = Vector sum of the three phases (R+S+T)

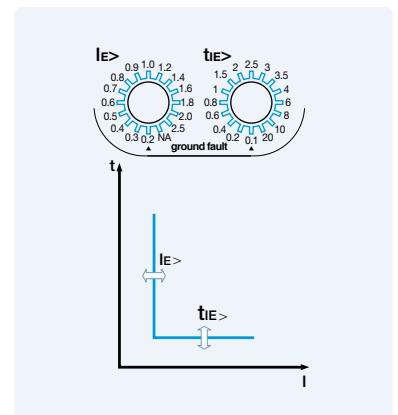

Major components

CT (Current Transformer)

Rating		Specification
Max. system voltage	kV	0.6
Primary current	A	7.2 / 14/4 / 28.8 / 57.6 / 115.2 / 230.4
Secondary current	A	0.075
Rated burden	VA	0.1
Accuracy class		10P80
Short time-current	KA/3s	21
Rated frequency	Hz	50 / 60



Voltage indicator lamps (Voltage Detector)

It is a device to check the presence or absence of voltage in the cables. It is conforming to IEC standard 61958. Push button type LED voltage indicator is provided and lamp power is supplied by bushing type capacitive dividers.



Power Fuse

1. The LS HRC power fuses belong to the PRIME MEC series. It interrupts high currents before the peak value and therefore cuts down the required withstand capacity of the associated equipment on the electric system.
2. Though small in size, it has a high breaking capacity and its enclosed type is suitable for use inside of the panel board.
3. By unifying the size of the connection, it facilitates compatibility and maintenance.



Selection of fuses

: According to IEC 60787(24kV)

Transformer rating capacity (kVA)	Power Fuse rated current (A)
36 ~ 75	5
75 ~ 157	10
172 ~ 358	20
258 ~ 538	30

Transformer rating capacity (kVA)	Power Fuse rated current (A)
464 ~ 840	40
598 ~ 1048	50
745 ~ 1320	63
1000 ~ 1572	75

(Note) Please ask fuse maker for optimum selection of fuses.

Power fuse characteristic curve

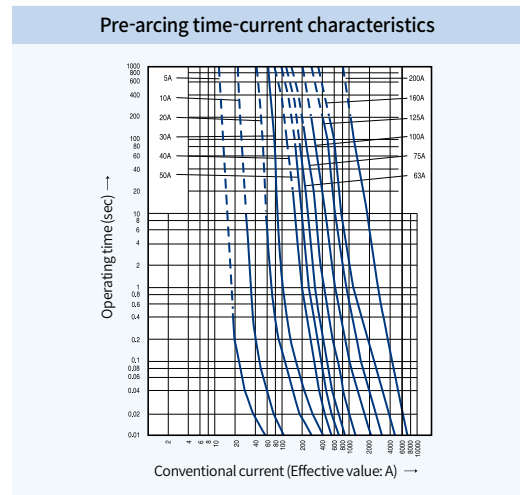
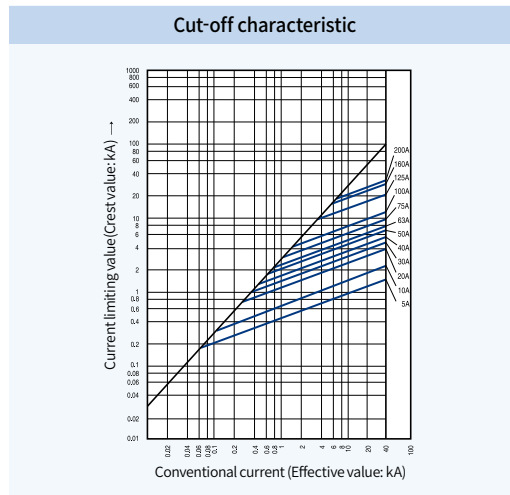

Optional components for LBS / F-LBS mechanism

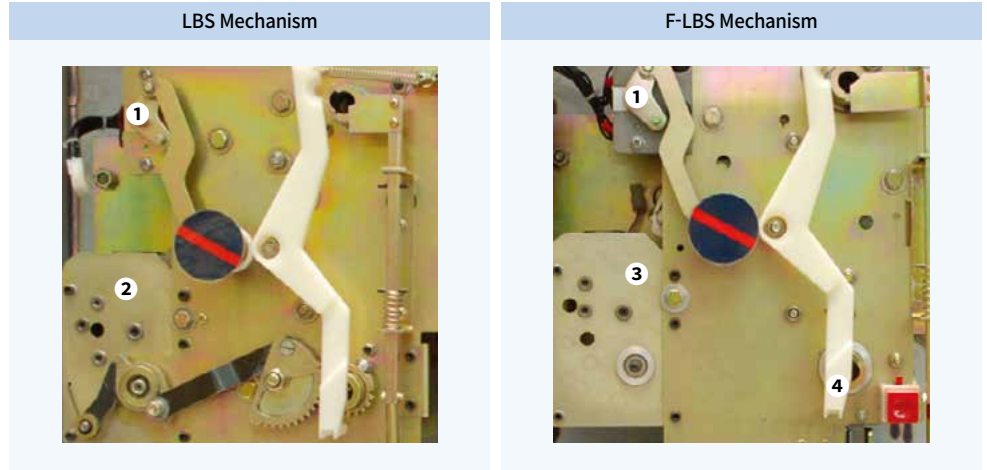

1 LBS/F-LBS auxiliary contact



A contact used for remote control of LBS/ F - LBS ON/OFF/EARTH status. The auxiliary contact consists of 2a2b. (However, when operating an electric motor, it consists of 1a1b.)

12 / 17.5 / 24 / 36kV RMU LBS Auxiliary Contact					
Type		Resistive load		Inductive load	
Minimum current		DC5V, 1mA			
Contact capacit	AC	490V	5A	2.5A	
		250V	10A	10A	
		125V	10A	10A	
	DC	250V	3A	1.5A	
		125V	10A	6A	
		30V	10A	6A	

2 LBS motor



With the external power source, it charges the closing/opening spring of LBS

12 / 17.5 / 24 / 36kV RMU LBS Motor					
Rated voltage (Vn)	DC 24~30V	DC 110V	DC 220V	AC 100~130V	AC 200~250V
Load current (A)	≤ 9	≤ 2	≤ 1	≤ 2	≤ 1
Starting current (A)	3 times the load current		5 times the load current		

3 F-LBS motor



With the external power source, it charges the closing/opening spring of F - LBS

12 / 17.5 / 24kV RMU F-LBS Motor					
Rated voltage (Vn)	DC 24~30V	DC 110V	DC 220V	AC 100~130V	AC 200~250V
Load current (A)	≤ 9	≤ 2	≤ 1	≤ 2	≤ 1
Starting current (A)	3 times the load current		5 times the load current		

4 F-LBS trip coil



A device used to trip F - LBS in a remote place; it trips F - LBS by operating the coil when voltage is continuously applied or instantaneously supplied

12 / 17.5 / 24kV RMU F-LBS Trip Coil				
Rated voltage (Vn)	DC 110V	DC 220V	AC 100~130V	AC 200~250V
Steady current (A)	≤ 3	≤ 2.5	≤ 3	≤ 2.5
Control voltage fluctuation range	70~110%		85~110%	

Optional components for CB mechanism

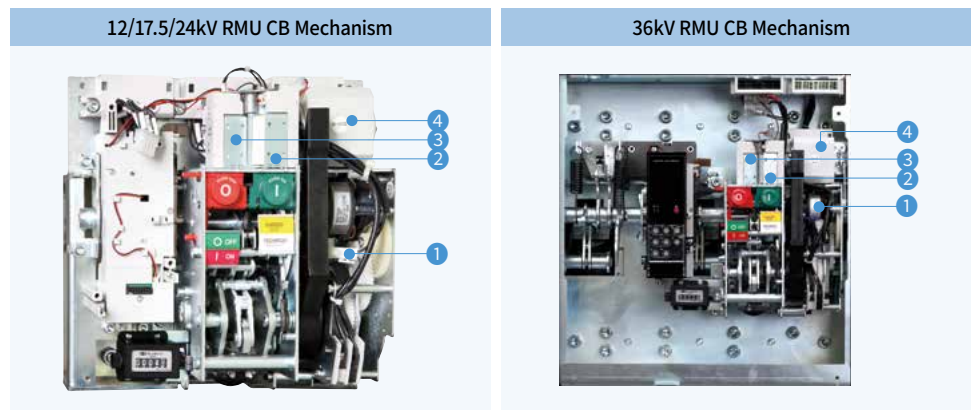

1 CB motor

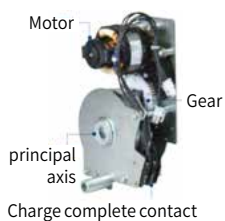

With the external power source, it charges the closing spring of CB. When charging is completed, the motor's control power is switched "OFF" by a built-in Limit S/W.

12/17.5/24/36kV RMU CB Motor							
Rated voltage(Vn)	DC 24~30V	DC 48~60V	DC 110V	DC 220V	AC 48V	AC 100 ~ 130V	AC 200 ~ 250V
Load current(A)	≤ 5	≤ 3	≤ 1	≤ 0.5	≤ 3	≤ 1	≤ 0.5
Starting current(A)	5 times the load current						
Charging time	(5 seconds or less) Charge						
Charge completion contact	10A at 250VAC						

2 CB closing coil



A control device to trip CB in a remote place; it closes a circuit breaker by operating the coil when voltage is continuously applied or instantaneously supplied (200ms or more).

12/17.5/24/36kV RMU CB Closing Coil							
Rated voltage(Vn)	DC 24~30V	DC 48~60V	DC 110V	DC 220V	AC 48V	AC 100 ~ 130V	AC 200 ~ 250V
Power consumption(W) Upon operation(Inrush)	200						
Power consumption(W) normal condition	≤ 5						

3 CB trip coil



- A control device to trip CB in a remote place; it trips a circuit breaker by operating the coil when voltage is continuously applied or instantaneously supplied (35ms or more).
- UVT Coil not applicable when a double trip coil is chosen

12/17.5/24/36kV RMU CB Trip Coil							
Rated voltage(Vn)	DC 24~30V	DC 48~60V	DC 110V	DC 220V	AC 48V	AC 100 ~ 130V	AC 200 ~ 250V
Power consumption(W) Upon operation(Inrush)	200						
Power consumption(W) normal condition	≤ 5						

4 CB auxiliary contact



- A contact used to remotely monitor ON/OFF status of a circuit breaker.
- The auxiliary contact consists of 4a4b

12/17.5/24/36kV RMU CB Auxiliary Contact							
Type	Resistive load			Inductive load			
Minimum current	DC5V, 1mA						
Contact capacity	AC	490V	5A			2.5A	
		250V	10A			10A	
		125V	10A			10A	
	DC	250V	3A			1.5A	
		125V	10A			6A	
		30V	10A			10A	

Under Voltage Trip device: Instantaneous type (Under Voltage Trip device: UVT)



UVT coil rated voltage and characteristics

- A device that automatically trips CB when the main line or control power voltage drops below the defined range. It is attached inside a circuit breaker.
- When no control power is supplied to UVT, CB's electrical and mechanical closing is not possible. For CB tripping, 65~85% of the rated voltage should be applied to both ends of the UVT coil.
- When the UVT Coil is selected, a double trip coil cannot be chosen. Thus, the trip coil location should be changed
- Dual trip coil can not be selected when UVT coil is selected and the trip coil position must be changed

12/17.5/24/36kV RMU CB UVT Coil						
Rated voltage (Vn)		Operating voltage range(V)		Power consumption (VA or W)		Trip time (ms)
DC(V)	AC(V)	Pick Up	Drop Out	Inrush	Steady-state	
24~30	-	0.65~0.85 Vn	0.4~0.6 Vn	200	≤ 5	50
48~60	48					
100~130	100~130					
200~250	200~250					

Note) Operating voltage range is the minimum rating standard of each rated voltage (Vn)

CB Remote Reset Switch: RES (Remote Reset switch: RES)

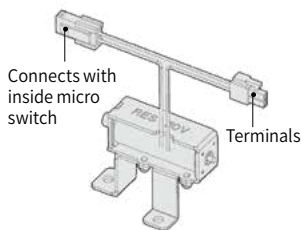

Rated voltage and operating current of RES

- It is an optional attachment that resets a circuit breaker in remote places when CB trip has occurred by OCR(Over Current Relay) owing to fault current.
- When a trip alarm(AL) switch is used, CB trip occurs. For CB re-closing, the circuit breaker should be mechanically reset. such mechanical reset operation is possible with a switch in remote places.
- When the circuit breaker is reset with a micro-switch inside the circuit breaker, it automatically breaks the current supplied to the coil inside a remote reset switch(RES). For safety, it is recommended to use a push button switch the operation switch. <Recommended specifications of the push button switch> (resistive load)
- AL2 and RES cannot be used simultaneously. Thus, there is only one option, either AL2 or RES.

12/17.5/24/36kV RMU CB RES Coil			
Rated voltage (Vn)	Operating current (Max)		Operating time
AC 110~130V	AC	6A	40ms or less
AC/DC 110~125V	DC	5A	
AC/DC 200~250V	AC / DC	3A	

CB-Trip alarm contact (Trip Alarm Contact: AL)

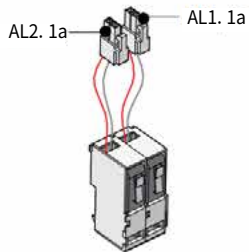

- When a Circuit Breaker is tripped by OCR which operates against the fault current(Over Current Relay), Trip Alarm switch provides the information regarding the trip of Circuit Breaker by sending the electrical signal from the mechanical indicator on main cover of main Circuit Breaker or internal auxiliary switch. (Installed at the inside of Circuit Breaker)
- When a Circuit Breaker is tripped by fault current, a mechanical trip indicator(MRB, Manual Reset Button) pops out from the main cover and the switch(AL) which sends control signal electrically is conducted to output the information occurred from fault Circuit Breaker
- MRB and AL can be operated only when tripped by OCR, but doesn't be operated by Off button and OFF operation of trip coil.
- To re-close a Circuit Breaker after a trip, press MRB to reset it for closing.
- 2pcs of electrical trip switch(AL1, AL2, 1a) are provided(Optional)
- Trip alarm contact and MRB(Manual Reset Button) need to be purchased together
- AL2 and RES cannot be used simultaneously. Thus, there is only one option, either AL2 or RES

Electrical characteristics of a trip alarm contact

12/17.5/24/36kV RMU CB Trip Alarm Contact					
Rated voltage (V)	Non-inductive load(A)		Inductive load(A)		Inrush current
	Resistive load	Lamp load	Inductive load	Motor load	
8V DC	11	3	6	3	Max. 24A
30V DC	10	3	6	3	
125V DC	0.6	0.1	0.6	0.1	
250V DC	0.3	0.05	0.3	0.05	
250V AC	11	1.5	6	2	

MRB (Manual Reset Button)

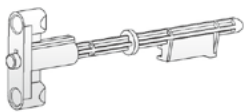

- It is a function which resets a Circuit Breaker manually when a Circuit Breaker is tripped by OCR.
- When a Circuit Breaker tripped by fault current, a mechanical trip indicator (MRB, Manual Reset Button) pops out from the main cover and the switch(SDE) which sends control signal electrically is conducted to output the information occurred from fault Circuit Breaker.
- MRB can be operated only by OCR but not by OFF operation of Circuit Breaker, To re-close a Circuit Breaker after a trip, press MRB to reset it for closing.

Non-Extensible CB feeder

12/17.5/24kV

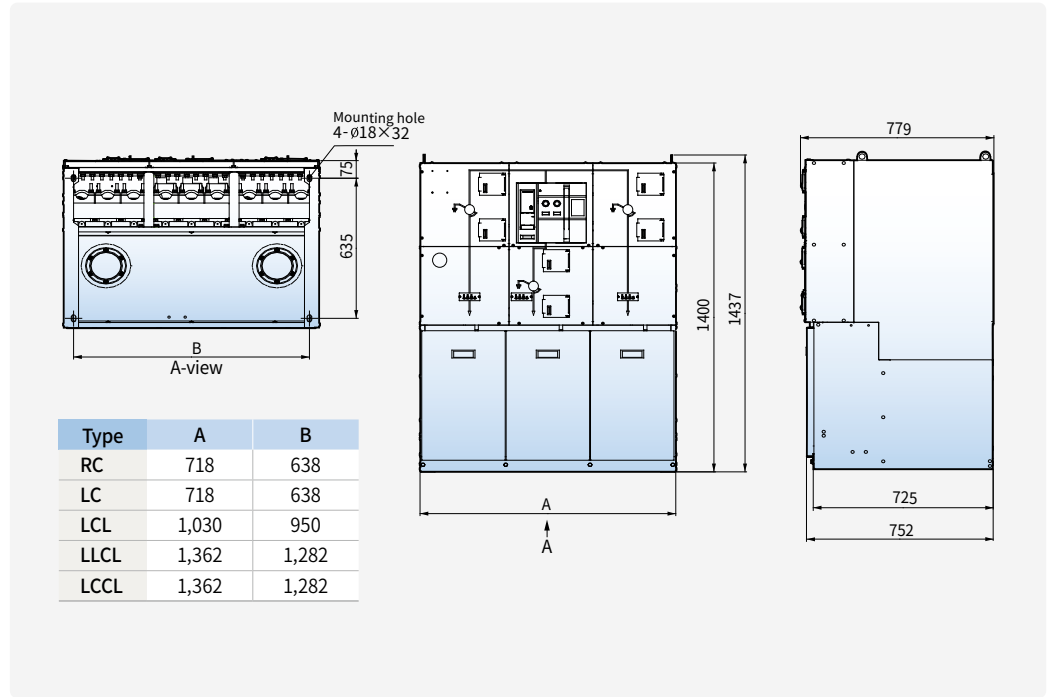

36kV

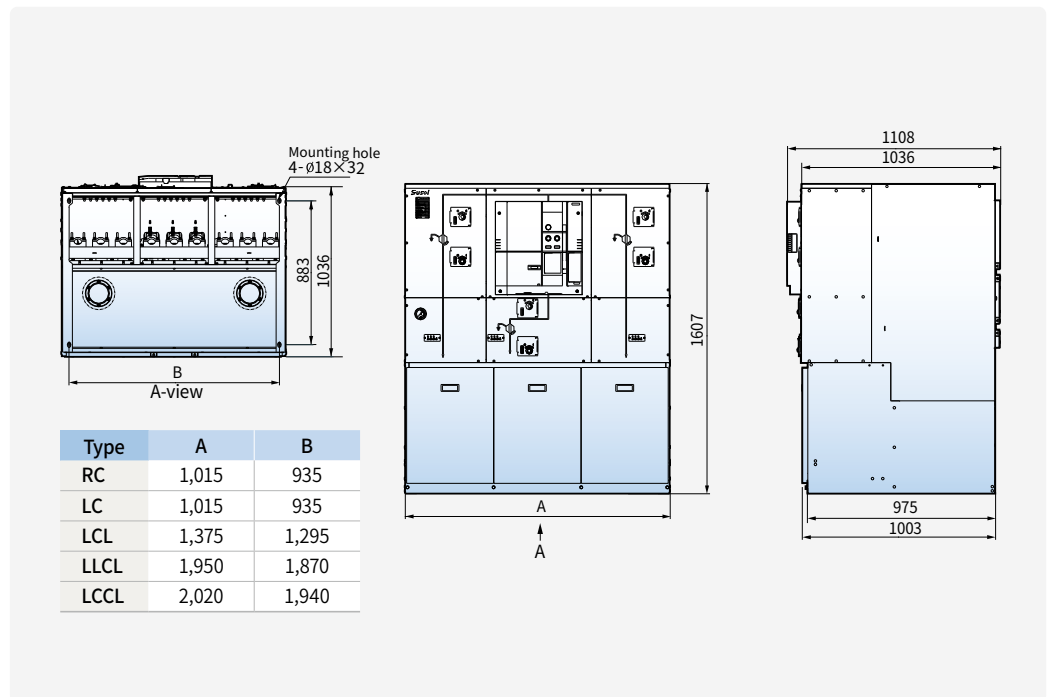

Dimensions

Non-Extensible switch-fuse feeder

12/17.5/24kV

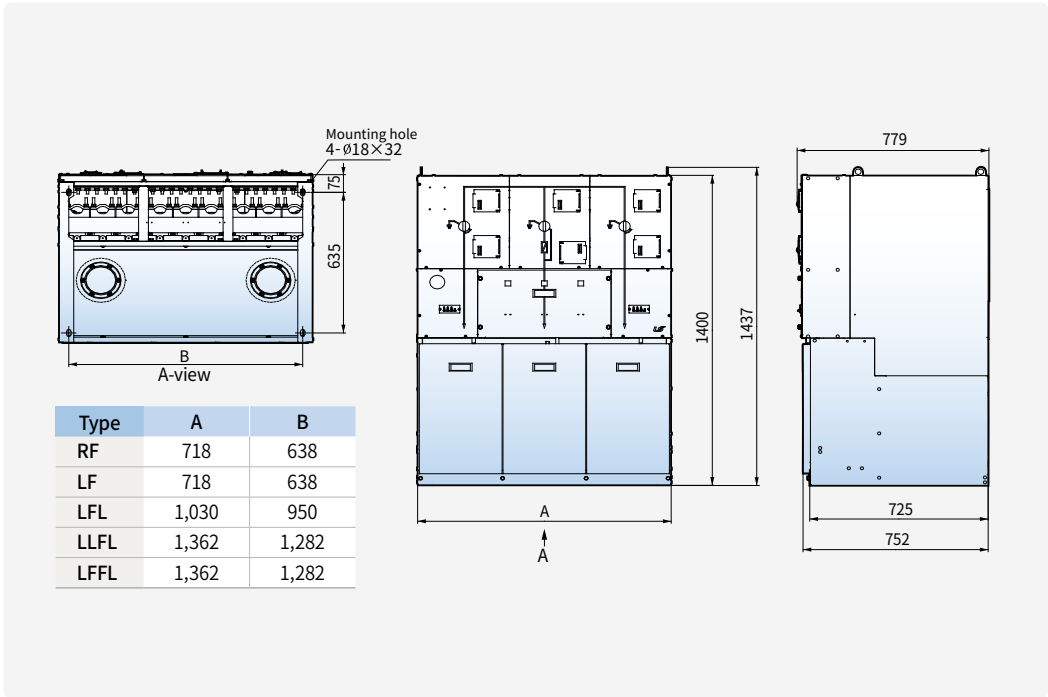

Non-Extensible LBS feeder

12/17.5/24kV

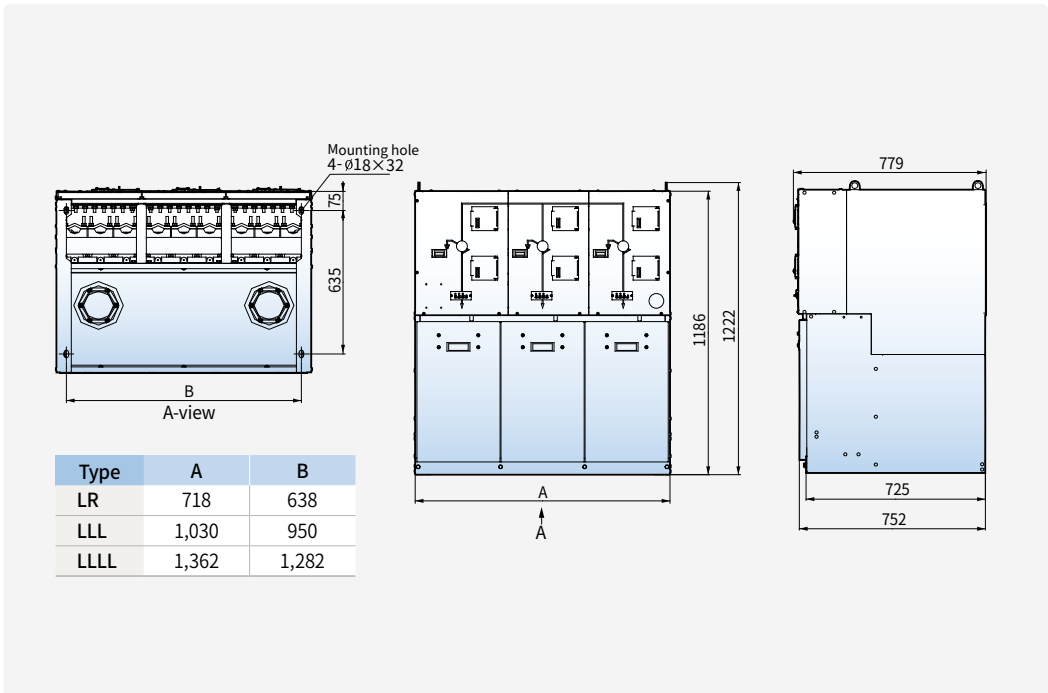

Extensible RMU

12/17.5/24kV

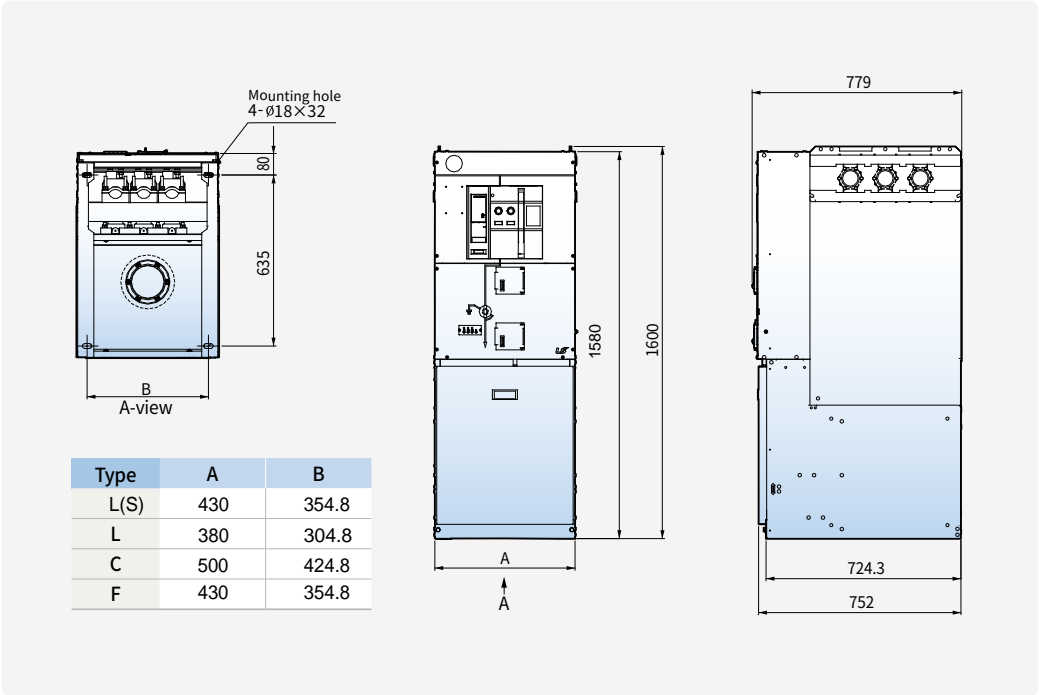

12/17.5/24kV
LLCL Multi-Circuit

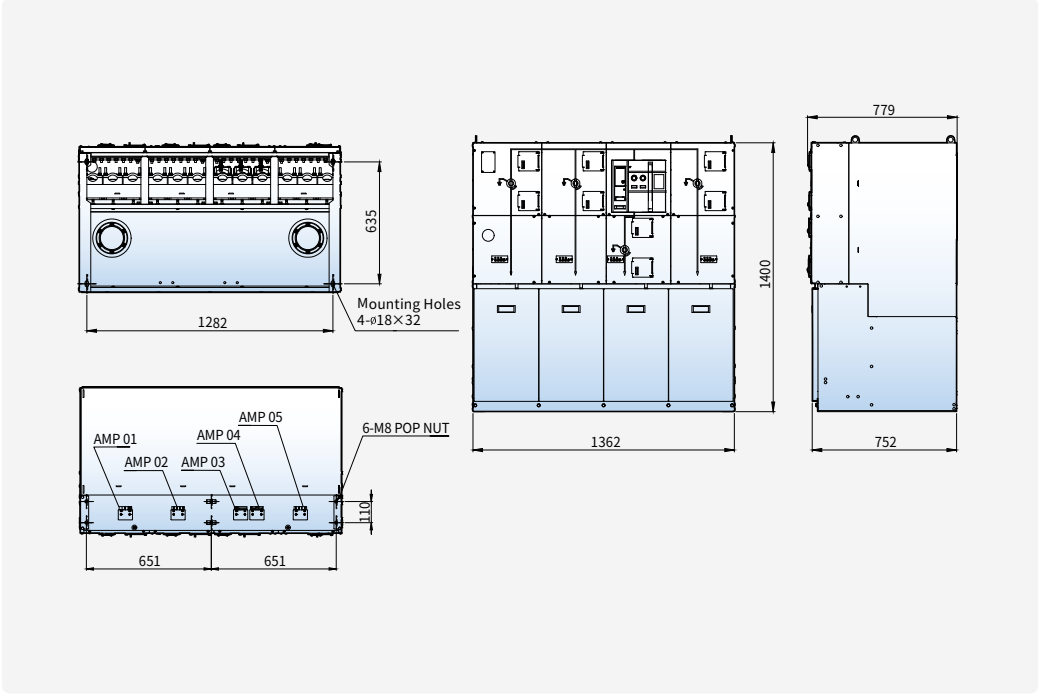

Memo

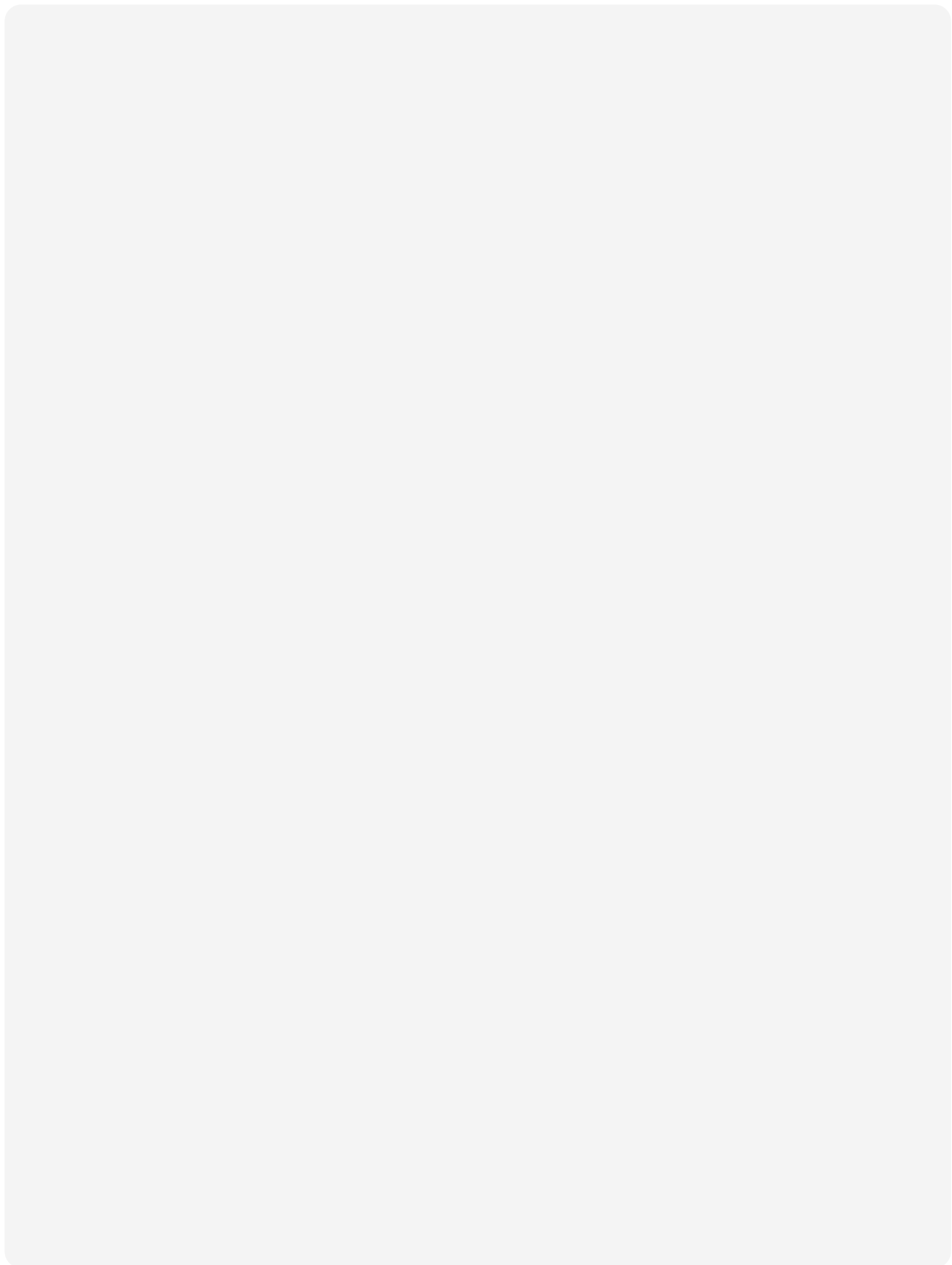

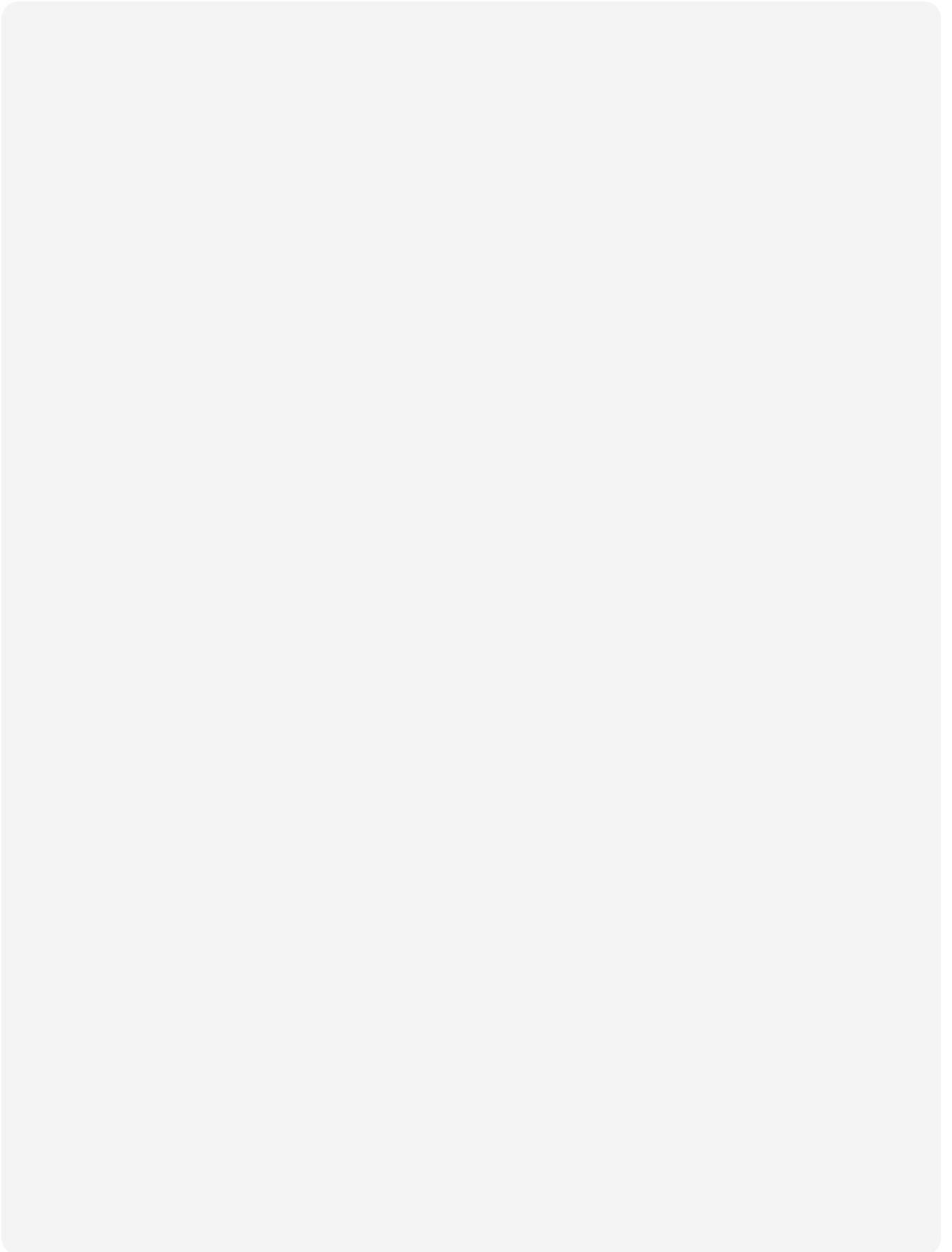



Safety Instructions

- For your safety, please read user's manual thoroughly before operating.
- Contact the nearest authorized service facility for examination, repair, or adjustment.
- Please contact qualified service technician when you need maintenance. Do not disassemble or repair by yourself!
- Any maintenance and inspection shall be performed by the personnel having expertise concerned.



- According to The WEEE Directive, please do not discard the device with your household waste.



www.ls-electric.com

■ Headquarter

LS-ro 127(Hogye-dong) Dongan-gu, Anyang-si, Gyeonggi-Do, 14119, Korea

■ Seoul Office

LS Yongsan Tower, 92, Hangang-daero, Yongsan-gu, Seoul, 04386, Korea
Tel: 82-2-2034-4916, 4684, 4429

■ Overseas Subsidiaries

- **LS ELECTRIC Japan Co., Ltd. (Tokyo, Japan)**
Tel: 81-3-6268-8241 E-Mail: japan@ls-electric.com
- **LS ELECTRIC (Dalian) Co., Ltd. (Dalian, China)**
Tel: 86-411-8730-5872 E-Mail: china.dalian@lselectric.com.cn
- **LS ELECTRIC (Wuxi) Co., Ltd. (Wuxi, China)**
Tel: 86-510-6851-6666 E-Mail: china.wuxi@lselectric.com.cn
- **LS ELECTRIC Vietnam Co., Ltd. (Hanoi, Vietnam)**
Tel: 84-222-2221-110 E-Mail: vietnam@ls-electric.com
- **LS ELECTRIC Middle East FZE (Dubai, U.A.E.)**
Tel: 971-4-886-5360 E-Mail: middleeast@ls-electric.com
- **LS ELECTRIC Europe B.V. (Hoofddorp, Netherlands)**
Tel: 31-20-654-1424 E-Mail: europartner@ls-electric.com
- **LS ELECTRIC America Inc. (Chicago, USA)**
Tel: 1-800-891-2941 E-Mail: sales.us@lselectricamerica.com
- **LS ENERGY Solutions LLC (Charlotte, USA)**
Tel: 1-704-587-4051 E-Mail: cmfeldman@ls-es.com
- **LS ELECTRIC Türkiye Co., Ltd. (Istanbul, Türkiye)**
Tel: 90-212-806-1252 E-Mail: turkiye@ls-electric.com
- **LS ELECTRIC IBERIA S.L.U. (Madrid, Spain)**
Tel: 34-910-28-02-74 E-Mail: iberia@ls-electric.com

■ Overseas Branches

- **LS ELECTRIC Tokyo Office (Japan)**
Tel: 81-3-6268-8241 E-Mail: tokyo@ls-electric.com
- **LS ELECTRIC Beijing Office (China)**
Tel: 86-10-5095-1631 E-Mail: china@lselectric.com.cn
- **LS ELECTRIC Shanghai Office (China)**
Tel: 86-21-5237-9977 E-Mail: china@lselectric.com.cn
- **LS ELECTRIC Guangzhou Office (China)**
Tel: 86-20-3818-2883 E-Mail: china@lselectric.com.cn
- **LS ELECTRIC Chengdu Office (China)**
Tel: 86-28-8670-3201 E-Mail: china@lselectric.com.cn
- **LS ELECTRIC Qingdao Office (China)**
Tel: 86-532-8501-2065 E-Mail: china@lselectric.com.cn
- **LS ELECTRIC Nanjing Office (China)**
Tel: 86-25-8467-0005 E-Mail: china@lselectric.com.cn
- **LS ELECTRIC Bangkok Office (Thailand)**
Tel: 66-90-950-9683 E-Mail: thailand@ls-electric.com
- **LS ELECTRIC Jakarta Office (Indonesia)**
Tel: 62-21-2933-7614 E-Mail: indonesia@ls-electric.com
- **LS ELECTRIC Moscow Office (Russia)**
Tel: 7-499-682-6130 E-Mail: info@lselectric-ru.com
- **LS ELECTRIC America Western Office (Santa Fe Springs, USA)**
Tel: 1-562-903-5527 E-Mail: america@ls-electric.com
- **LS ELECTRIC India Office (India)**
Tel: 91-80-6142-9108 E-Mail: Info_india@ls-electric.com
- **LS ELECTRIC Singapore Office (Singapore)**
Tel: 65-6958-8162 E-Mail: singapore@ls-electric.com
- **LS ELECTRIC Italy office (Italy)**
Tel: 39-030-8081-833 E-Mail: italia@ls-electric.com